

PRO Fail Safe COOKTOP Model

Thank you for your purchase. *STOVE GUARD* is an electronic safety device for use with electric range with built-in cooktops. It turns the cooktop OFF when you forget by using the advanced technology found in security monitoring devices and a specially programmed microcontroller.

STOVE GUARD controls the cooktop's electrical system to help prevent food and pots from burning, as well as reducing the risk of fire caused by unattended cooking which is the leading cause of kitchen fires.

***STOVE GUARD* is preset at the factory at the highest fire safety setting.**

This is the recommended setting for use by anyone with Alzheimer's or similar medical condition.

- When properly installed, adjusted, and set in **AUTO** mode, *STOVE GUARD* will automatically shut the electric cooktop OFF if no one is present in the monitored cooking area for a preset period of time.
- Upon returning to the cooking area, *STOVE GUARD* will detect their presence and automatically turn the cooktop ON again. The preset time will reset to the last setting.
- *STOVE GUARD* can also be used in a **TIMER** mode to set a maximum cooking time, after which the cooktop will be automatically turned OFF.

IMPORTANT WARNING

- Installation of *STOVE GUARD* COOKTOP Model **requires the use of a licensed Electrician** to be wired properly according to local electrical codes.
- Do not disassemble any of the components. There are no user serviceable parts inside. Refer servicing to a qualified person only.

IMPORTANT TECHNICAL SAFEGUARDS

DO NOT INSTALL the EMU (Electronic Monitoring Unit):

Directly above a heat source or where hot/cold air or steam will blow onto it.

On or above a microwave or toaster oven,

Directly on or above the cooktop.

Do not allow grease to build up on the sensing unit. This will reduce *STOVE GUARD*'s sensing range and possibly turn the cooktop OFF even when someone is at the cooktop.

Clean the outer surface of the EMU with a clean, damp cloth only. Do not use soaps or cleaning liquids.

STOVE GUARD must be tested with the individual who requires this device and adjusted to their personal needs, as well as adjusted to the home environment of use to ensure proper functioning. Additional fire safety devices; such as smoke detectors & fire extinguishers must also be used to ensure complete cooking fire safety.

WHAT'S INCLUDED (UNPACKING CHECKLIST)

- Power Box
- EMU (Electronic Monitoring Unit)
- Wall mounting screws (2 short) and under cabinet screws (2 long)
- Instruction Manual

POWER BOX

1. Main Power 220-240V wire opening/clamp
2. 240VAC 0.7A Fuse
3. Rocker Switch to Control 120V Power
(Must be set during installation)
4. EMU Cord Opening
5. Mounting Brackets
6. Control Cord to EMU Sensor/Timer

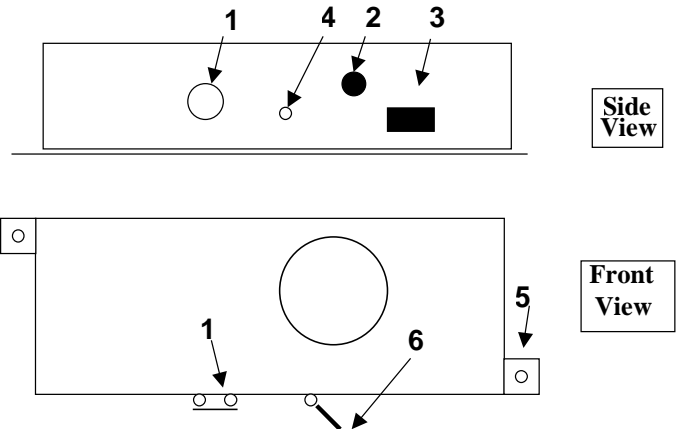

INSTALLING THE POWER BOX

**STOVE GUARD cooktop model MUST BE INSTALLED BY A LICENSED ELECTRICIAN
according to local electrical codes.**

Failure to use a professional will result in possible loss of life, warranty and property insurance.

1. Shut off power to the cooktop at the service panel.
2. Access the cooktop wiring.
3. Remove the *STOVE GUARD* Power Box cover & refer to the wiring diagram.
4. Disconnect the existing cooktop power wires & feed into the *STOVE GUARD* Power Box.
5. Make connections according to the enclosed wiring diagram on the last page.
6. Replace the *STOVE GUARD* Power Box cover.
7. Connect the thin white cable from the Power Box (#6 on the Power Box Diagram) to the receptacle in the back of the EMU, by lining up the pins on the connector, do not use force. Route the cable in the recessed groove.
8. Turn power to the cooktop back ON.
9. For the safety reasons, after a power failure or after the first use of *STOVE GUARD* the cooktop will remain turned off until user presses any button on the Electronic Monitor Unit. All settings are going to the factory default. Green On LED should be blinking, green Auto LED light. A time of **00** minutes should appear on the TIME display. Press the AUTO button. Green On LED, and green Auto LED should light. Green Sensor LED will light when movement is detected. A time of **01** minute should appear on the display. (A time of 1 minute is the factory default preset.)

10. Setting the Rocker Switch on Power Box to the proper position: Make sure nothing is on the top of cooktop. Turn a burner on a low setting. Test the Stove Guard by standing out of the EMU's sensor detection area. After 1 minute, power to the cooktop burner should be shut off. Do not touch the burner... It may be hot... If the burner does not shut off, switch the rocker switch on the *STOVE GUARD* Power Box to the other operating position (#3 on the Power Box Diagram).
11. Carefully making sure that the white cable is routed properly up to the EMU. Mount the EMU to an upper kitchen cabinet, or to the wall.
12. Test *STOVE GUARD* in its various modes and instruct the final user on Stove Guard's proper use.

EMU - ELECTRONIC MONITORING UNIT

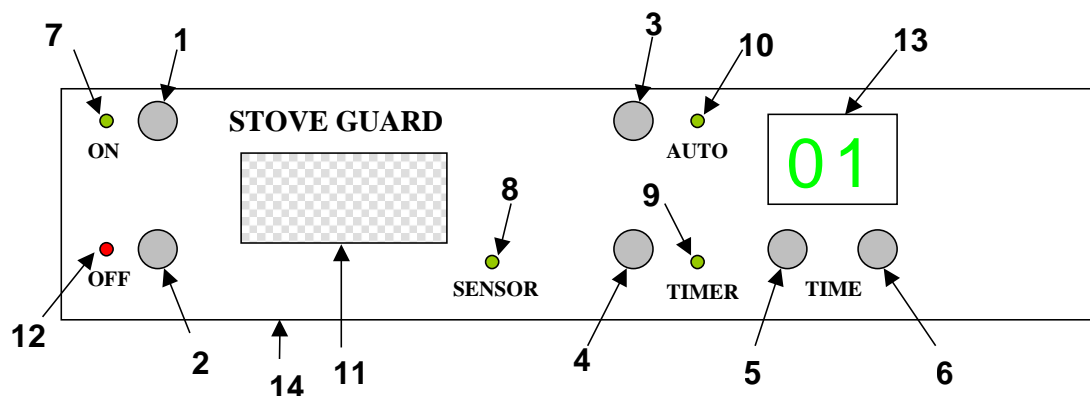

- | | |
|--|--|
| <ol style="list-style-type: none"> 1. ON button 2. OFF button 3. AUTO MODE button to activate Motion Detector (PIR) 4. TIMER MODE button 5. TIME ADJUST button in 10 minute intervals 6. TIME ADJUST button in 1 minute intervals 7. ON Indicator LED | <ol style="list-style-type: none"> 8. MOVEMENT indicator LED for PIR 9. TIMER MODE indicator LED 10. AUTO MODE indicator LED 11. Motion Sensor window for PIR 12. OFF indicator LED 13. TIME display 14. Sensor height level adjustment screw - to raise or lower the sensor's field of view (Normally does not need to be adjusted). |
|--|--|

INSTALLING the EMU (Electronic Monitoring Unit)

The best location for mounting the EMU is under an upper kitchen cabinet approximately 12" (30cm) from the right or left side of the cooktop, or on the wall approximately 18" (45cm) from the right or left side of the cooktop.

Remember: DO NOT place it directly on or above the cooktop.

MOUNTING TO THE BOTTOM OF A KITCHEN CABINET

- Remove the plastic covers from the 2 holes on the top and bottom of the EMU.
- Feed the two long screws from the bottom to the top of the EMU and screw directly into the bottom of the cabinet.
- Ensure that the cable is properly routed back to the Power Box.

MOUNTING TO THE WALL

- Mark 2 points on the wall exactly 7 1/16 " (18cm) apart.
- Drill 2 holes and install two short screws, leaving the screw threads exposed approx. 1/4" (6mm).
- Line up & Place the EMU on the screw heads and slide it down.
- Ensure that the cable is properly routed back to the Power Box.

USING STOVE GUARD

STOVE GUARD has 2 easy to use operating modes: ON/AUTO and ON/TIMER

ON/AUTO Mode:

Pressing any button after power failure (or the first use), or the ON button in OFF mode, or AUTO button in TIMER mode starts *STOVE GUARD* in AUTO mode, automatically protecting the cooktop user.

This setting provides the maximum protection & no further setting is required.

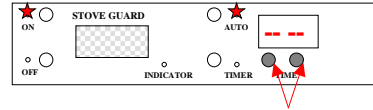
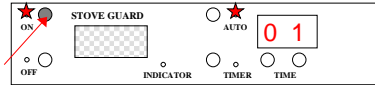

The ON/AUTO mode allows the PIR (*motion detector*) in the EMU to automatically shut the cooktop off if the user is out of the sensing area for longer than the preset time (*1 minute is the factory-preset time*).

When the user re-enters the sensing area *approximately 10-12 feet (3-4m) line of site from the EMU*, the *STOVE GUARD* will turn the cooktop back on and reset to the last preset time.

There is no need to reset the timer each time.

NOTE: Time Display will show dashes (—) instead of number of minutes left when *STOVE GUARD* is in it's resting state (no current is detected for more then 4 minutes – all burners and oven are turned off). As soon as a burner or oven is turned on, **01** or adjusted number of minutes will be displayed.

The amount of Time can be adjusted to your personal preference by using the **TIME ADJUST** buttons.

ON/TIMER Mode:

Press and hold the TIMER button for 3 seconds in AUTO mode starts *STOVE GUARD* in TIMER mode. *STOVE GUARD* allows the cooktop to operate only as long as determined by the preset TIME when operating in TIMER countdown mode,.

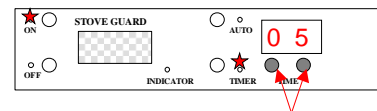
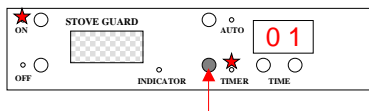

Press and hold the TIMER button to start TIMER Mode.

The TIMER function **must be reset manually** on each occasion you wish to use the cooktop in TIMER mode. This is because the PIR (*motion detector*) does not control the cooktop when the Electronic Monitoring Unit (EMU) is set to the TIMER mode.

Time can be adjusted using the **TIME ADJUST** buttons, to the cooking time of a specific dish.

Once the time is counted down, the cooktop will be turned off.

Returns to AUTO Mode by pressing the AUTO button.

OFF: Press and hold OFF button for 4 seconds in AUTO or TIMER mode turns the *STOVE GUARD* off (**OFF mode**).

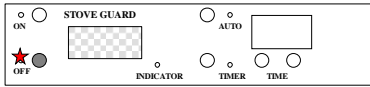

The cooktop retains its regular functions when *STOVE GUARD* is in the OFF mode.

WARNING: *STOVE GUARD*'s Safety Features are **DISABLED** In OFF Mode.

ADJUSTING the PRESET TIMES

NOTE: User has to hold the TIME ADJUST buttons for more than 3 seconds in order to adjust the preset times.

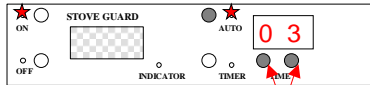
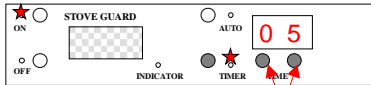
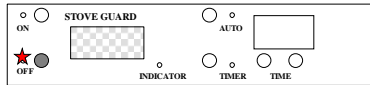
 <p style="text-align: center;">ON/AUTO</p>	 <p style="text-align: center;">ON/TIMER</p>	 <p style="text-align: center;">OFF</p>
<p>To preset the TIME in AUTO mode: Press the AUTO button and set the time from 01-15 minutes by pressing the TIME ADJUST buttons.</p> <p>A time of less than 7 minutes is recommended; factory-preset is 1 minute.</p>	<p>To operate in TIMER mode: Press and hold the TIMER button until the green TIMER indicator lights. Set the time between 01 minute and 7.0 hours by using the TIME ADJUST buttons, depending on the time required to cook a specific dish. When the time is over, the cooktop will automatically shut off. The left button adds 10 minutes or 1 hour and the right button adds 1 minutes or 0.1 hour (6 minutes) to the timer. After reaching 99 minutes the time goes to 1.7 hours. After reaching the maximum (7.0 hours) time goes to the minimum (01 minute). Display will show number of minutes left before Stove Guard turns off the cooktop. When decimal point between digits lights, the display shows hours and tenth of hours.</p> <p>Movement in the sensing area does not affect the timer at all. The timing function must be manually reset every time the cooktop is used in TIMER mode.</p>	<p>Press and hold the OFF button until the red OFF indicator starts to blink. The display is blank. When the Stove Guard is in the OFF mode the cooktop retains its regular function, and the Stove Guard's safety features are inactive. For safety reason one hour after Stove Guard is in OFF mode and cooktop is turned off (current is not detected) Stove Guard automatically goes to AUTO mode.</p> <p style="text-align: center;">Press the ON button to turn <i>STOVE GUARD</i> back to ON/AUTO mode.</p>

THE ADVANCED SETTINGS

When Stove Guard is in the OFF mode and user holds the AUTO button while pressing the ON button the user can change the time setting to automatically return from OFF mode. Display shows "A1" – It is the factory default time - one hour after Stove Guard is in the OFF mode and cooktop is turned off (current is not detected) Stove Guard automatically goes to AUTO mode. User could change this time with right TIME ADJUST button to "A2" - 2 hours or to "A0" - Stove Guard remain in OFF mode as long as user doesn't press the ON button. By pressing left Time Adjust button user could change meaning of ON green LED. Factory setting is "On" - indicator lights when Stove Guard is ON - operating in AUTO

or TIMER mode. Other possibilities are "OC" - indicator lights when current is detected, or "OP" - indicator lights when the cooktop has power and indicators doesn't light when Stove Guard turns off the cooktop. User will have to press OFF or TIMER button when parameters are set.

THE RELAY OUTPUT

The relay output with 3.5mm mono audio jack in Stove Guard monitor unit make a change from open contact to closed and after 0.8 seconds goes back to open every time when Stove Guard turns the cooktop off. It can be used to trigger an external monitoring device, whenever the Stove Guard disables the cooktop; such as a Phone Dialer or Alarm system.

SENSING LEVEL ADJUSTMENT (Height Adjustment)

The sensing range of the EMU (*Electronic Monitoring Unit*) is over 4 meters (around 12 feet) at a radius of 110 degrees. Each time the motion sensor is activated, the green INDICATOR LED flashes (#8 on EMU Diagram).

- *STOVE GUARD* features an adjustable sensing height level to prevent the activation of the cooktop by small children or pets that might be detected by the motion sensor (PIR).
- There is a screw located underneath the EMU, which allows you to adjust the viewing height range of the PIR. Normally this does not need to be adjusted.

Note: This adjustment should only be done in the following situations:

1. It is determined that the PIR is detecting movements other than those of the intended *STOVE GUARD* user (*such as small children, pets, etc.*) which will pass within the lower portion of it's detection field.
 - To **RAISE the detection field** when the EMU cannot be located higher, slowly turn the screw to the **LEFT**.
2. *STOVE GUARD* is not detecting the movements of the user because its location is set very high up; the user is very short, or seated in a wheelchair.
 - To **LOWER the detection field** for these situations, slowly turn the screw to the **RIGHT**.

TROUBLESHOOTING

Why is there a very slight "...humming sound..." coming from the Stove Guard's power box?

This humming sound is normal; the sound is emitted from the energized coils in the power relays. These relay coils must be energized to allow the operation of the safety feature called "...Fail Safe...". This important added safety feature makes the Stove Guard tamper proof, this means that if any wires are purposely disconnected to try to disarm Stove Guard the cooktop will not operate. This adds to the many safety functions we have included in the new "...PRO..." model.

If this slight humming sound is annoying to you, try to lay the Power Box on the floor instead of mounting it to the wall... When attached firmly to the wall or metal surface the sound may be amplified.

The EMU's LED's do not light up:

- Check the cooktop fuse or circuit breaker to ensure power is reaching the cooktop.
- Check that all the connections to the *STOVE GUARD* Power Box and EMU are properly connected and press the ON button.
- Check the fuse in the *STOVE GUARD* Power Box (#2 on *POWER BOX diagram*).

The green INDICATOR LED flashes without any reason:

Avoid placing the EMU within the proximity of the following sources of interference that might accidentally trigger the PIR (*Motion Detector*):

- Reflective Surfaces: direct air flow from vents, fans and windows.
- Sources of steam or cooking oil vapor.
- Infrared light sources: TV or other IR Remote Controls
- Objects causing temperature changes: such as heaters, refrigerators, toasters and ovens.
- Do not place objects that a pet can climb onto (e.g. a cat on furniture) within 10 feet of the EMU, or furniture higher than 3 ft.
- In addition, do not aim the EMU at a stairway a pet may have access to.

When there was a loss of power (*Electrical Outage*) the *STOVE GUARD* keeps the cooktop turned off until user press any button. All settings goes to factory default (e.g. A time of 1 minute is the factory default preset time in AUTO mode for turning off the cooktop with no movement detected.).

- *STOVE GUARD* may need to be adjusted to your own personal needs.

LIMITED WARRANTY POLICY EFFECTIVE OCT 2006

Stove Guard International Ltd. (SGI) warrants its products to be free from defects and workmanship for a period of (2) two years from original date of purchase. SGI agrees to repair or replace, at its sole discretion, the defective product if returned to SGI within the warranty period and with proof of purchase.

All *STOVE GUARD* devices are tested and inspected three times by a qualified electrical inspector and by our own factory before they are packed and shipped. *STOVE GUARD* has been inspected by QPS Field Evaluation Services, authorized Agency of Intela Inc. Evaluation based on CSA model code SP-1000 for sale in Canada and the USA.

IF SERVICE IS REQUIRED UNDER THIS WARRANTY

1. Call us at 1-888-607-8683 (1-888-60-STOVE) or email us at: techsupport@stoveguard.ca to obtain a return merchandise authorization number (RMA).
2. Return the defective unit postage paid to the address shown below.
3. Enclose proof of purchase.
4. SGI is not responsible for shipping charges or shipping damage to units returned under warranty. Item should be packed carefully in its original carton.

This warranty does not extend to any SGI products, which have been subject to misuse, accidents, incorrect wiring, modifications in any way or to use in violation of operating instructions furnished by SGI, nor extend to any units altered or repaired for warranty defect by anyone other than SGI.

This warranty does not cover any incidental or consequential damages and is in lieu of all other warranties expressed or implied and no representative or person is authorized to assume for us, any other liability in connection with the sale of our products.

FOR TECHNICAL SUPPORT PLEASE CONTACT

STOVE GUARD INTERNATIONAL LTD.

106-2750 Faithfull Avenue. Saskatoon, SK S7K 6M6 CANADA

Ph: 1-888-607-8683

Email: techsupport@stoveguardintl.com

Website: www.stoveguardintl.com

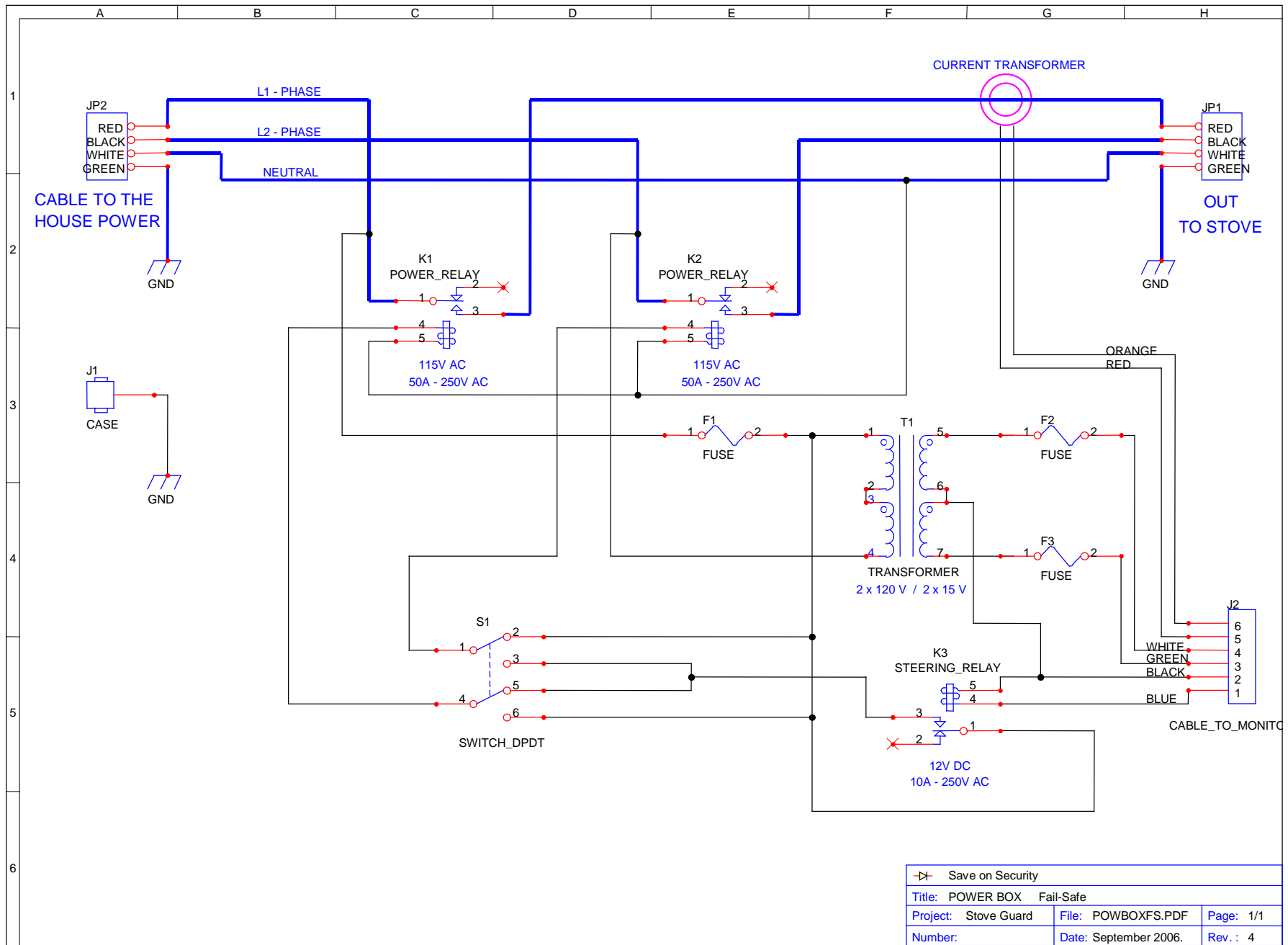

NOTE: Installer has to add wires drawn in blue.